



FEEL
THE
DIFFERENCE!

Figure Skates Collection

2017 | 2018

GRAF SKATES/ THE COMPANY

EN

ICE SKATES FROM SWISS PRODUCTION

Graf & Co. was established in Kreuzlingen in 1921 by Karl Graf's grandfather. Graf then produced a wide range of all kinds of sport shoes: from soccer, -bike, -hiking, up to tennis boots, etc. In 1937 the first ice skates were introduced and since 1974 GRAF became specialists in ice hockey and figure skating boots. Since 1997 GRAF has been producing high-quality hockey and figure skating boots for the Canadian and North American market. 85% of the skates produced by GRAF SKATES AG in Switzerland are sold worldwide. Main markets amongst others are Russia, Scandinavia and Germany. For the Japanese market ice skates are produced on particular lasts (shape of foot).

EXPENSIVE PRODUCTION

A high-quality ice skate is composed of many individual parts built together in a very complex way. Every stage of production from cutting out the boots, sewing, lasting, gluing the sole and assembling the blades requires professionalism and specialized knowledge. It is only possible to produce such high quality goods at competitive prices with the investment of such special machines as GRAF SKATES AG has. For the development of new models and technology, the input of customers and direct contacts with consumers are of high value. New products originate from customers inquiries, needs and co-creations by consumers. The testing of new materials is of great significance.

QUALITY COMES TO THE FORE

All employees of the Graf Company both in Kreuzlingen, Switzerland and in Calgary, Canada work everyday to achieve the level of quality which GRAF is known for.

DE

SCHLITTSCHUHE AUS SCHWEIZER PRODUKTION

Gegründet wurde das Unternehmen Graf & Co. 1921 im thurgauischen Kreuzlingen durch den Grossvater von Karl Graf. Die Sportschuhfabrik stellte ein breites Sortiment von Sportschuhen her: vom Fussball-, Rad-, Wander-, Tennis bis hin zum Schwingerschuh. Ab 1937 wurden Schlittschuhe ins Sortiment aufgenommen und ab 1974 begann die Spezialisierung auf Eishockey- und Kunstlaufschuhe. Seit 1997 produziert GRAF hochwertige Eishockey- und Kunstlaufmodelle für den nordamerikanischen Markt. GRAF SKATES AG, Kreuzlingen exportiert rund 85% der Produktion weltweit ausser nach USA und Kanada. Hauptmärkte sind u.a. Russland, Skandinavien und Deutschland. Für den japanischen Markt werden Schlittschuhe mit speziellen Leisten (Fussformen) hergestellt.

AUFWENDIGE PRODUKTION

Ein hochwertiger Schlittschuh besteht aus sehr vielen Einzelteilen. Dementsprechend aufwendig ist die Produktion. Vom Ausstanzen über das Nähen, das Zwicken, das Aufkleben der Sohle bis hin zur Montage der Kufen wird der Schlittschuh in maschineller Handarbeit gefertigt. Nur durch gezielte Investitionen in Spezialmaschinen kann eine derart arbeits- und materialintensive Produktion zu marktgerechten Preisen beibehalten werden. Für die Entwicklung neuer Modelle und Technologien haben die Inputs von Kunden und direkte Kontakte mit Konsumenten einen hohen Stellenwert. Aus Nachfrage, Kundenbedürfnissen und Co-Kreation entstehen neue Produkte. Grosse Bedeutung wird dabei dem Testen von neuen Materialien beigemessen.

QUALITÄT STEHT IM VORDERGRUND

Dafür setzen sich täglich alle Mitarbeiterinnen und Mitarbeiter von GRAF in Kreuzlingen, Schweiz und in Calgary, Kanada ein.

FR

DES PATINS PRODUITS EN SUISSE

L'entreprise Graf & Co. a été fondée en 1921 dans la cité thurgovienne de Kreuzlingen par le grand-père de Karl Graf. La fabrique de chaussures de sport proposait un large assortiment: chaussures de football, de cyclisme, de tennis, de randonnée, etc. Dès 1937, les patins ont rejoint cette panoplie et, dès 1974, l'entreprise s'est spécialisée dans les patins de hockey et de patinage artistique. Depuis 1997, GRAF produit des modèles de haute qualité pour le hockey et le patinage artistique pour le marché canadien et de l'Amérique de Nord. GRAF SKATES SA à Kreuzlingen exporte environ 85% de sa production à travers le monde, à l'exception des Etats-Unis et du Canada. Les marchés principaux se trouvent en Russie, en Scandinavie et en Allemagne. Pour le marché japonais, des patins avec spéciaux formes de pieds sont fabriqués.

COÛTEUSE PRODUCTION

Un patin de haute qualité exige beaucoup d'attention sur les détails. Ce qui signifie des coûts de production élevés. De la découpe à la couture, le serrage, le collage des semelles au montage des lames, les patins sont minutieusement terminés à la main. C'est seulement grâce à des investissements dans des machines spécialisées qu'une telle production intensive peut assurer un rapport qualité-prix compétitif pour le marché. Pour le développement de nouveaux modèles et de nouvelles technologies, les impressions et remarques des clients, de même que le contact direct avec les consommateurs sont essentiels. Les nouveaux produits résultent de la demande et des besoins de la clientèle. Un très grand intérêt est donné aux tests effectués sur les matériaux.

LA QUALITÉ D'ABORD

Toutes les collaboratrices et tous les collaborateurs de l'entreprise GRAF à Kreuzlingen en Suisse et à Calgary au Canada travaillent quotidiennement en ce sens.

FIT COMES FIRST SPECIAL ORDER/ GRAF

This is our goal, because with personalized skates you can jump higher, turn more precise, train longer and get a better support. GRAF special order is worthwhile for skaters who want precisely fitted skates or are having trouble with stock skates. These skates are exclusively produced and handcrafted in Switzerland.

Das ist unser Ziel, weil man mit besseren Schlittschuhen höher springen, präziser drehen, länger trainieren kann und einen besseren Halt hat. Eine GRAF Extraanfertigung lohnt sich für Läufer, die einen passgenauen Schlittschuh nach Wunsch möchten oder mit Schlittschuhen aus dem Handel Beschwerden haben. Diese Schlittschuhe werden exklusiv in der Schweiz hergestellt und bearbeitet.

SOME POSSIBILITIES:

- ONLY BOOTS, ALTERED BLADES
- SPECIAL WIDTH, SKATES ACCORDING TO TRACINGS, HEAT MOLDING
- EXTRA-STIFF/SOFT, SPECIAL TONGUES, MATERIAL ADDITION/CHANGING
- REACTIVATION OF OUTDATED MODELS, SOLE PARTS OF OTHER MODELS
- DIFFERENT SIZES L/R, HEEL PADDING AND MANY MORE

Many athletes count on the quality of GRAF special orders. You can improve your performance, too! Ask your GRAF dealer or send us an email to support@grafskates.ch

Viele Profis zählen auf die Qualität von GRAF Extraanfertigungen, verbessere auch du deine Leistung! Frage deinen GRAF Händler oder schreibe uns eine Mail auf support@grafskates.ch





ANATOMY OF THE GRAF SKATE/

KNOWN FIGURE SKATING CHAMPIONS HAVE CHOSEN GRAF SKATES.

IF YOU ARE AIMING FOR SUCCESS, YOUR FOOTWEAR SHOULD HELP YOU SUCCEED. GRAF HAS BEEN OFFERING CUTTING-EDGE DESIGNS AND MATERIALS SINCE 1921, ENABLING YOU SO TO LEAVE A MARK WITH YOUR PERFORMANCE.

MAXIMUM COMFORT FOR MAXIMUM PERFORMANCE.

- 1 PADDED TONGUE
- 2 TONGUE PADDING
- 3 UPPER PADDING 3D
- 4 HIGH QUALITY MICROFIBRE LINING (1,2 mm)
- 5 TONGUE PADDING IN BETWEEN
- 6 TONGUE COVER STRIPE
- 7 HEEL COUNTER REINFORCEMENT & PADDING
- 8 ANKLE PADDING
- 9 FOOTBED
- 10 INSOLE
- 11 OUTSOLE
- 12 GENUINE LEATHER UPPER
- 13 TOE REINFORCEMENT

BLADE ASSEMBLY/

FOR THE ASSEMBLY OF THE ICE BLADE FOLLOW THE INSTRUCTIONS BELOW.

IT IS RECOMMENDED THAT THE ASSEMBLY IS CARRIED OUT BY SPECIALIZED PERSONNEL.

1. PLACE THE BLADE AND MARK WITH A PEN THE POSITION OF THE HOLES.

2. DRILL HOLES AT THE MARKED POINTS WITH A TIP 2.5 MM. THE HOLES IN THE HEEL MUST HAVE A DEPTH OF 15 MM, IN THE PLANTAR HOLES MUST BE "BYSTANDERS".

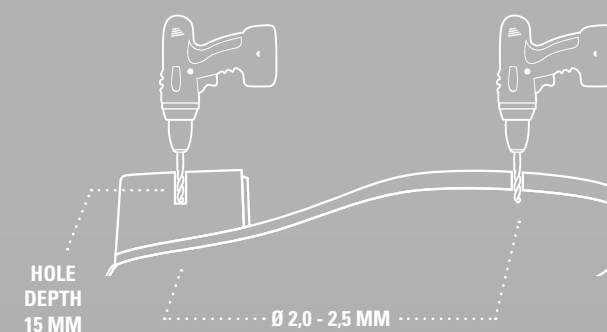

NEW GRAF™ ULTRALIGHT OUTSOLE/

THE NEW GRAF ULTRALIGHT-OUTSOLE IS THE RESULT OF YEARS OF EXPERIENCE IN PRODUCTION OF SKATES AND CLOSE COOPERATION WITH FIGURE SKATING EXPERTS AND ATHLETES. IT OFFERS ALL THE ADVANTAGES OF A CLASSIC GRAF OUTSOLE WITH 26% LOSS OF WEIGHT. THE MOST IMPORTANT IMPROVEMENT IS THE SRPP SURFACE, WHICH IS ALSO USED ON HOCKEY SKATES. IT IS EXTREMELY LIGHTWEIGHT, ROBUST AND OFFERS A FLAT CONTACT SURFACE FOR EASY BLADE MOUNTING. OUR TAPERED EDGE PROFILE ALLOWS EVEN MORE CURVE INCLINATION WITHOUT TOUCHING THE ICE.

THE ULTRALIGHT-OUTSOLE WILL BE USED AS A STANDARD ON ALL TOP-LEVEL MODELS AND RICHMOND SPECIAL AND CAN BE ORDERED WITH GRAF CUSTOM ORDERS.

26% **UL SOLE**
**LIGHTER THAN
CLASSIC OUTSOLE**

PROTECTION FRAME AGAINST HUMIDITY

LEATHER MIDSOLE WITH TAPERED EDGE PROFILE

1,4MM SRPP SURFACE

STANDARD "GRAF" LIGHT RED BEECHWOOD HEEL WITH GENUINE LEATHER COVER

ADAPTABLE SHOCK-ABSORBING 4 MM RUBBER HEEL LIFT



* comes with "GRAF" custom screws



EDMONTON SPECIAL/CLASSIC PROFESSIONAL OUTFIT

EN
Upper made of first class leather, high side stability, NEW: extra-light leather sole, professional model for the highest pretensions.

DE
Schuh aus erstklassigem Leder, hohe Seitenstabilität, NEU: leichtere Ledersohle, Profimodell für höchste Ansprüche.

FR
Chaussure en cuir de premier choix, haute stabilité latérale, NOUVEAU: semelle en cuir extra légère, Modèle professionnel pour les exigences les plus hautes.

Available woman sizes/ White leather **UL SOLE**

Nr. 2597-20 *M,L | 2 | 9

Catalog:
Fr. 649,00

* size S on request

Available woman sizes/ Beige leather **UL SOLE**

Nr. 2597-28 *M,L | 2 | 9

Catalog:
Fr. 649,00

* size S on request

Available Color/

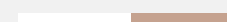

EDMONTON SPECIAL/BACK CUT



EN - Skates for slim ankles

DE - Skates für schlanke Fesseln

FR - Patins pour chevilles étroites



Available woman sizes/ White leather **UL SOLE**

Nr. 2597/BC-20 *M,L | 2 | 8

Catalog:
Fr. 649,00

* size S on request



EDMONTON SPECIAL/CLASSIC
PROFESSIONAL OUTFIT



EN
Upper made of first class leather, high side stability, NEW: extra-light leather sole, professional model for the highest pretensions.

DE
Schuh aus erstklassigem Leder, hohe Seitenstabilität, NEU: leichtere Ledersohle, Profimodell für höchste Ansprüche.

FR
Chaussure en cuir de premier choix, haut stabilité latérale, NOUVEAU: semelle en cuir extra légère, Modèle professionnel pour les exigences les plus hautes.

Available man sizes/ Black velours TX3

Nr. 2597-19	*L	▶	3	5.5	Catalog: Fr. 599,00
-------------	----	---	---	-----	------------------------

* size M on request

Available man sizes/ Black leather

Nr. 2697-19	*L	▶	3	5.5	Catalog: Fr. 599,00
-------------	----	---	---	-----	------------------------

* size M on request

Nr. 2597-29	*L	▶	6	12	Catalog: Fr. 679,00
-------------	----	---	---	----	------------------------

* size M on request

Nr. 2697-29	*L	▶	6	12	Catalog: Fr. 679,00
-------------	----	---	---	----	------------------------

* size M on request

Available Colors/
█

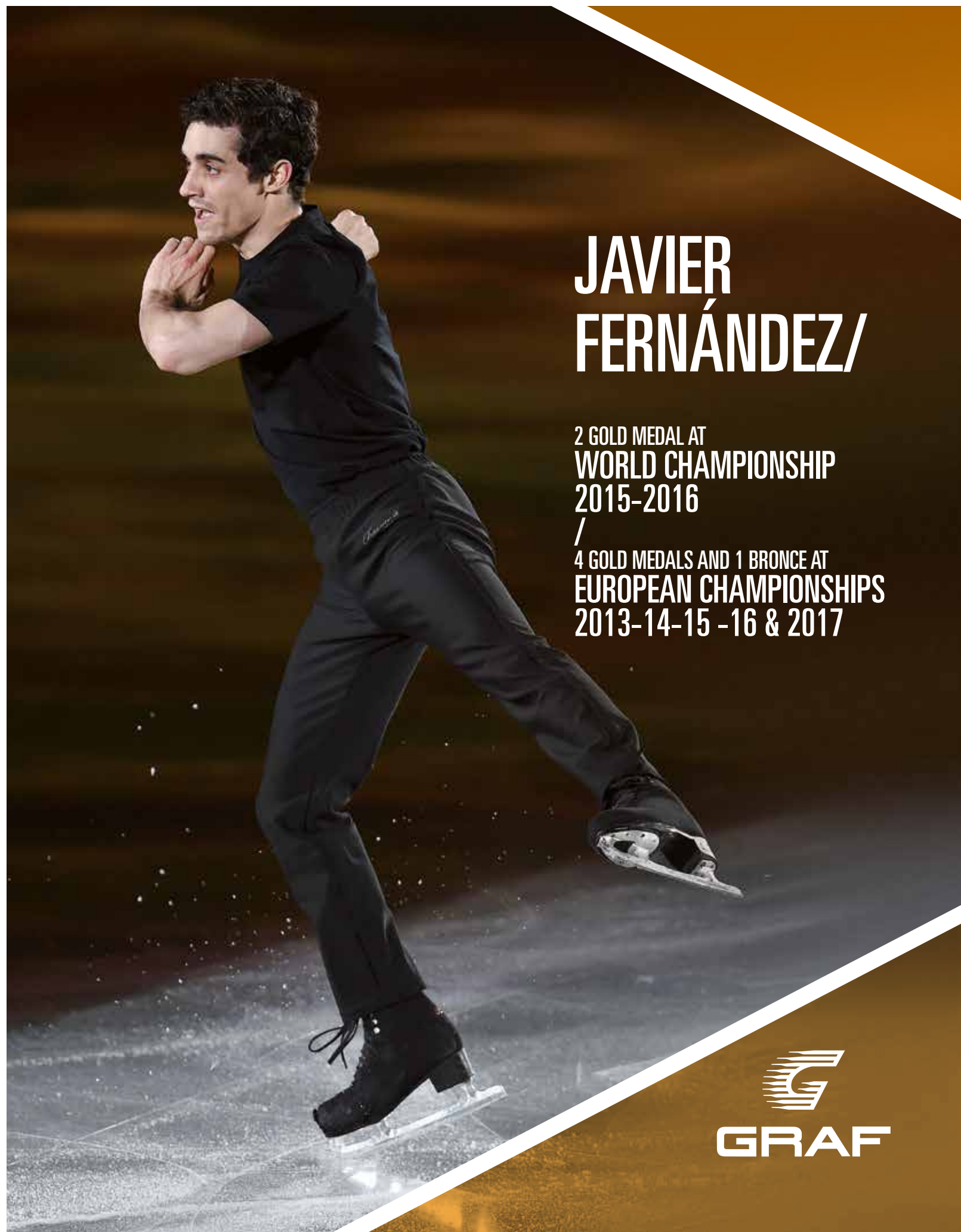

JAVIER FERNÁNDEZ/

2 GOLD MEDAL AT
WORLD CHAMPIONSHIP
2015-2016
/
4 GOLD MEDALS AND 1 BRONCE AT
EUROPEAN CHAMPIONSHIPS
2013-14-15 -16 & 2017





EDMONTON SPECIAL/V-INSERT PROFESSIONAL OUTFIT



EN
Course of movements and jumps are stressing a leather upper extremely. The built in part "V-Insert" absorb a great part of impacts and is slowing down the advanced tiredness of the leather. V-Insert facilitates the breaking-in phase considerably.

DE
Bewegungsablauf und Sprünge belasten einen Lederschaft äusserst stark. Das Einbauteil "V-Insert" absorbiert einen Grossteil der Belastung und verzögert dadurch die vorzeitige Ermüdung des Lederschaftes. Das Einfahren wird durch den V-Insert wesentlich erleichtert.

FR
La série des mouvements et sauts fragilisent une tige en cuir. La pièce d'encastrement "V-Insert" absorbe une grande partie des charges et diminue l'usure statique précoce du cuir. V-Insert facilite l'adapition des patins essentiellement.

Available **man sizes/ Black velours TX3**

Nr. 2597/V-29 *L 6 12 **Catalog: Fr. 679,00**

* size M on request

Available **man sizes/ Black leather**

Nr. 2697/V-29 *L 6 12 **Catalog: Fr. 679,00**

* size M on request

Available **Colors/**



EDMONTON SPECIAL/V-INSERT PROFESSIONAL OUTFIT



EN
Course of movements and jumps are stressing a leather upper extremely. The built in part "V-Insert" absorb a great part of impacts and is slowing down the advanced tiredness of the leather. V-Insert facilitates the breaking-in phase considerably.

DE
Bewegungsablauf und Sprünge belasten einen Lederschaft äusserst stark. Das Einbauteil "V-Insert" absorbiert einen Grossteil der Belastung und verzögert dadurch die vorzeitige Ermüdung des Lederschaftes. Das Einfahren wird durch den V-Insert wesentlich erleichtert.

FR
La série des mouvements et sauts fragilisent une tige en cuir. La pièce d'encastrement "V-Insert" absorbe une grande partie des charges et diminue l'usure statique précoce du cuir. V-Insert facilite l'adapition des patins essentiellement.

Available **woman sizes/ White leather** **UL SOLE**

Nr. 2597/V-20 *M,L 2 9 **Catalog: Fr. 649,00**

* size S on request

Available **Colors/**

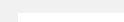

WASHINGTON/ PROFESSIONAL OUTFIT EXTRA STIFF



EN
This model distinguish itself by the extreme high upper stability "X-STIFF". Comfortable liner, excellent ankle padding and soft padded upper border.

DE
Dieses Modell zeichnet sich durch die extrem hohe Schaft-Stabilität "X-STIFF" aus. Bequemer Innenschuh, gute Knöchelpolsterung und weich gepolsterter Schaftabschluss.

FR
Ce modèle se distingue par sa extrême haute stabilité latérale "X-STIFF". Intérieure confortable, rembourrage de la cheville et haut de la tige agréablement mou.

Available **woman sizes/ White leather** **UL SOLE**

Nr. 2598-20 M,L 3 9 **Catalog: Fr. 699,00**

* size S on request

Available **man sizes/ Black velours TX3**

Nr. 2598-29 L 6 12 **Catalog: Fr. 699,00**

* size M on request

Available **Colors/**

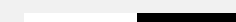

DANCE/ PROFESSIONAL OUTFIT



EN
Special model for icedancing with lower backstripe, made of first class leather, excellent side-stability.

DE
Spezialmodell für Eistanz mit tiefem Schaftabschluss, aus erstklassigem Leder, hohe Seitenstabilität.

FR
Bottine spéciale pour la danse avec une forme incurvée à l'arrière de la tige, en cuir de premier choix, excellente stabilité latérale.

Available **woman sizes/ White leather** **UL SOLE**

Nr. 2593-20 M,L 2 9 **Catalog: Fr. 649,00**

* size S on request

Available **woman sizes/ Beige velours TX3** **UL SOLE**

Nr. 2593-28 M,L 2 9 **Catalog: Fr. 649,00**

* size S on request

Available **man sizes/ Black velours TX3**

Nr. 2593-29 L 5 11.5 **Catalog: Fr. 679,00**

* size M on request

Available **Colors/**





WINDSOR/ PROFESSIONAL OUTFIT

EN
Model Windsor the perfect completion to model Edmonton Classic. Windsor is an all-rounder for highest performance. Excellent side stability, low back padding for more flexibility in the sector of the Achilles tendon.

DE
Modell Windsor die perfekte Ergänzung zu Modell Edmonton Classic: Windsor ist ein Multitalent für höchste Performance. Hohe seitliche Stabilität, tiefes Fersenpolster für erhöhte Beweglichkeit im Bereich der Achilles-Sehne.

FR
Modèle Windsor est le complément parfait au modèle Edmonton classique: Windsor est un multitalent pour haute performance. Haute stabilité latérale, rembourrage incurvée à l'arrière de la bottine offrant meilleure flexibilité au tendon Achille.

Available woman sizes/ White leather **UL SOLE**

Nr. 2670-20 *M,L 3 8 **Catalog: Fr. 649,00**

* size S on request

Available Colors/



F4000/ PROFESSIONAL OUTFIT

**LEVEL 2
DOUBLE
JUMPS**

EN
Middle hard boot, upper made of especially for skating developed leather, comfortable ankle pads, soft padded, good side-stability.

DE
Mittelharter Schuh aus speziell für Eiskunstlauf entwickeltem Rindleder, komfortable und weiche Knöchelpolsterung, gute Seitenstabilität.

FR
Tige de dureté moyenne en matériel spécial cuir spécialement développé pour le patinage, confortable rembourrage pour la cheville, bonne stabilité latérale.

Available woman sizes/ White leather **UL SOLE**

Nr. 2594-20 *M,L 1 8 **Catalog: Fr. 599,00**

* size S on request

Available man sizes/ Black leather

Nr. 2594-29 *L 6 12 **Catalog: Fr. 629,00**

* size M on request



GALAXY/ PROFESSIONAL OUTFIT

**TOP
LEVEL**

EN
Boot made of special material "CP" with Fitting System and new styling, excellent side-stability.

DE
Schuh aus Spezial-Material "CP" mit Fitting-System und neu angepasstem Modellschnitt, hohe Seitenstabilität.

FR
Tige en matériel spécial "CP" avec Fitting-System et nouvelle coupe modèle, haute stabilité latérale.

Available woman sizes/ White **UL SOLE**

Nr. 2692-20 *M,L 2 8 **Catalog: Fr. 649,00**

* size S on request

Available Colors/

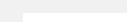

RICHMOND SPECIAL/ PROFESSIONAL OUTFIT

**LEVEL 2
DOUBLE
JUMPS**

EN
Middle hard boot, upper made of especially for skating developed leather, adapted styling, Fitting-System, very good side-stability.

DE
Mittelharter Schuh aus speziell für Eislauf entwickeltem Rindleder, angepasster Modellschnitt, Fitting-System, sehr gute Seitenstabilität.

FR
Bottine de dureté moyenne en matériel spécial cuir spécialement développé pour le patinage, coupe modèle adaptée, très bonne stabilité latérale.

Available woman sizes/ White color **UL SOLE**

Nr. 2591-0 *M,L 10c 1.5 **Catalog: Fr. 349,00**

* size S on request

NEW: 13,5C

Nr. 2591-0 M,L 2 8 **Catalog: Fr. 499,00**

* size S on request

Available man sizes/ Black color

Nr. 2591-19 *L 13c 1.5 **Catalog: Fr. 389,00**

* size M on request

NEW: 13,5C

Nr. 2591-29 L 2 8 **Catalog: Fr. 529,00**

* size M on request

Available Colors/

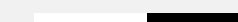



BOOTS ONLY - Nr. 2589/NS-0

LEVEL 1
SINGLE
JUMPS

PRESTIGE/ PROFESSIONAL OUTFIT

EN

Leather upper, lining out of high quality microfibres material. High side stability. Basic model for the ambitious skater. Equipped with quality blades LAUSANNE.

DE

Obermaterial aus Rindleder, Futter aus hochwertigem Microfaser-Material. Hohe Stabilität. Basis-Modell für den anspruchsvollen Eiskunstläufer. Mit Qualitäts-Kufen LAUSANNE.

FR

Tige en cuir, doublure en matériel microfibres de haute qualité. Haute stabilité latérale. Modèle de base pour le patineur exigeant. Equipé des lames de qualité LAUSANNE.

Available woman sizes/ White color

Nr. 2589-0 / M,L ● 7c 12c **Catalog: Fr. 269,00**

Nr. 2589/SK-0 / M,L ◻ 13c 2.5 **Catalog: Fr. 349,00**

Nr. 2589/SK-0 / M,L ◻ 3 9 **Catalog: Fr. 369,00**

Only Boots:

Nr. 2589/NS-0 / M,L ◻ 7c 8 **Catalog: Fr. 259,00**

Available man sizes/ Black color

Nr. 2589-19 / L ◻ 1 5.5 **Catalog: Fr. 369,00**

Nr. 2589-29 / L ◻ 6 12 **Catalog: Fr. 389,00**

Only Boots:

Nr. 2589/NS-29 / M,L ◻ 1 12 **Catalog: Fr. 279,00**

Available Colors/



ACE/

EN - Youth model, upper made of CP, AIRNET lining, leather sole, blades screwed.

FR - Modèle pour la jeunesse, tige en CP, doublure en AIRNET, semelle cuire, lames vissées.

DE - Jugendmodell, Schaft aus CP, AIRNET-Futter, Ledersohlen, Eisen geschraubt.

Available woman sizes/ White

Nr. 2577-10 / *M ● 7c 13c **Catalog: Fr. 199,00**

* size S on request

Nr. 2577-10 / *M ◻ 13.5c 4.5 **Catalog: Fr. 219,00**

* size S on request

NEW: 13,5C

Only Boots:

Nr. 2577/NS-10 / *M ● 7 13c **Catalog: Fr. 177,00**

* size S on request

Nr. 2577/NS-10 / *M ◻ 13.5c 4.5 **Catalog: Fr. 197,00**

* size S on request

NEW: 13,5C

Available man sizes/ Black

Nr. 2577-19 / *L ● 7c 13c **Catalog: Fr. 199,00**

* size M on request

Nr. 2577-19 / *L ◻ 13.5c 4.5 **Catalog: Fr. 219,00**

* size M on request

NEW: 13,5C

Only Boots:

Nr. 2577/NS-19 / *L ● 7 13c **Catalog: Fr. 177,00**

* size M on request

Nr. 2577/NS-19 / *L ◻ 13.5c 4.5 **Catalog: Fr. 197,00**

* size M on request

NEW: 13,5C

Available Colors/

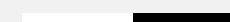

CAPRICE/

NEW

EN - Medium rigidity, upper made of especially for skating developed leather Materials of two layers, PU-coated microfiber with genuine leather offers optimal fit. Soft tongue padding and comfortable liner. Ultra-light outsole. GRAF M-IV blades.

DE - Mittelharter Schuh aus speziell für Eislauf entwickeltem Leder bestehend aus zwei Schichten kombiniert mit PU-beschichteter Mikrofaser und echtem Leder. Der Schuh passt sich optimal an den Fuss an. Weiche Zungenpolsterung und komfortables Futter. Ultra-light Sohle. GRAF M-IV Kufen.

Available woman sizes/

Nr. 2580/SK-0 / M,L ◻ 2 2.5 **Catalog: Fr. 279,00**

Nr. 2580/SK-0 / M,L ◻ 3 8 **Catalog: Fr. 299,00**



DAVOS GOLD/ FREE TIME

EN
Synthetic leather upper, reinforced, lining in "Air-Activ" special respiratory material.

DE
Schaft aus Synthetik-Leder, verstärkt, Comfort-Polsterung, atmungsaktives Spezial-Futter "Air-Activ".

FR
Tige renforcée en cuir synthétique, doublure spéciale active respiratoire "Air-Activ".

Available woman sizes/

Nr. 2170-01 ● 25 35 **Catalog:**
Fr. 74,90

Nr. 2170-02 ● 36 43 **Catalog:**
Fr. 84,90

Available Colors/

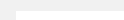

BOLERO CRYSTAL/ FREE TIME

NEW

EN
Synthetic leather upper, reinforced, comfort padding, lining special respiratory material. Original Swarovski crystal decor. GRAF blades.

DE
Schaft aus synthetischem Leder, verstärkt, Comfort-Polsterung, atmungsaktives Spezial-Futter. ORIGINAL Swarovski Kristalldekor. GRAF Kufen.

Available woman sizes/ White color

Nr. 2175/CR-01 ● 25 35 **Catalog:**
Fr. 139,90

Nr. 2175/CR-02 ● 36 44 **Catalog:**
Fr. 149,90

Available man sizes/ Black color

Nr. 2175-29 ● 34 47 **Catalog:**
Fr. 164,90

Available Colors/

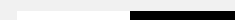

AROSA GOLD/ FREE TIME

EN
Well reinforced leather upper, quality lining SH 10, blades riveted A-4.

DE
Schaft aus Leder, gut verstärkt, atmungsaktives Qualitäts-Futter SH 10, Eisen genietet A-4.

FR
Tige toute en cuir, bien renforcée, doublure de qualité SH 10, lames rivées A-4.

Available woman sizes/

Nr. 2275-01 ● 27 35 **Catalog:**
Fr. 159,90

Nr. 2275-02 ● 36 43 **Catalog:**
Fr. 169,90

Available Colors/

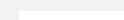

REVUE/ FREE TIME

EN
Upper made of leather, warm wool lining, soft tongue padding, ankle support. Blades riveted.

DE
Obermaterial aus Rindleder, warmes Wollfutter, weiches Zungenpolster, Gelenkstützen. Eisen genietet.

FR
Tige en cuir, doublure chaude en laine, languette rembourrée. Soutien de cambrure. Lames rivées.

Available woman sizes/

Nr. 2284-02 ● 36 43 **Catalog:**
Fr. 179,90

Available Colors/

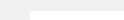



SPLENDID/ FREE TIME

EN
Upper made of leather, AIRNET lining, padded tongue, ankle support, blades riveted.

DE
Obermaterial aus Rindleder, AIRNET-Futter, weiches Zungenpolster, Gelenkstütze, Eisen genietet.

FR
Tige en cuir, doublure en AIRNET, languette rembourrée, soutien de cambrure, lames rivées.

Available woman sizes/ White

Nr. 2288-02



36

44

Catalog:
Fr. 179,90

Available Colors/



SPLENDID GOLD/ FREE TIME

EN
Upper made of leather, Clarino lining, soft padded collar and tongue, excellent side stability, ankle support, quality blades M-IV screwed.

DE
Obermaterial aus Rindleder, Clarino-Futter, gepolsterter Schaftabschluss, weiches Zungenpolster, gute Seitenstabilität, Gelenkstütze, Ledersohle, Qualitäts-Eisen M-IV geschraubt.

FR
Tige en cuir, doublure Clarino, colle de la tige et languette bien rembourrées, excellente stabilité latérale, soutien de cambrure, semelle en cuir, lames de qualité M-IV vissées.

Available woman sizes/ White

Nr. 2588-02



36

43

Catalog:
Fr. 299,00

Available Colors/

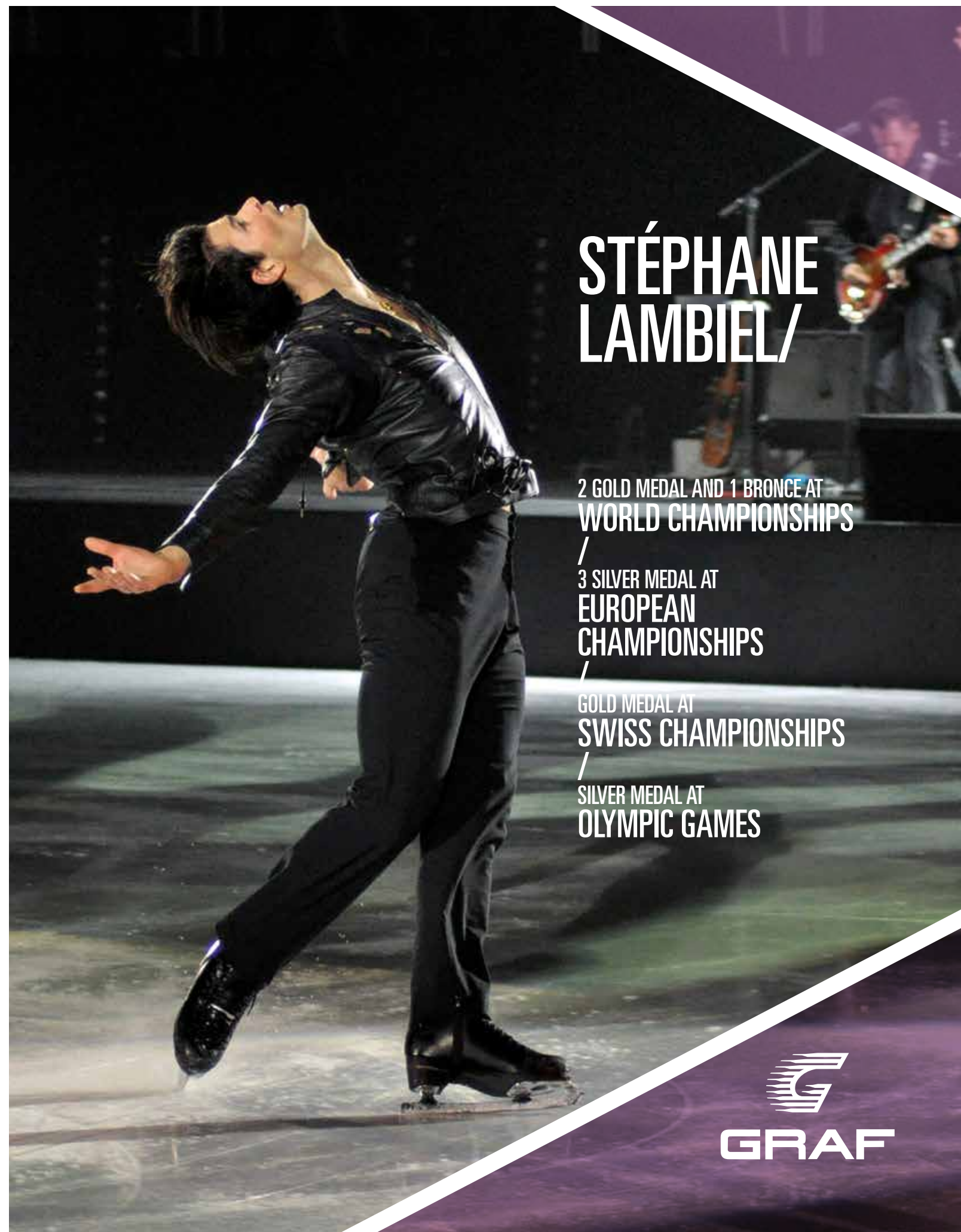

STÉPHANE LAMBIEL/

2 GOLD MEDAL AND 1 BRONZE AT
WORLD CHAMPIONSHIPS

3 SILVER MEDAL AT
EUROPEAN
CHAMPIONSHIPS

GOLD MEDAL AT
SWISS CHAMPIONSHIPS

SILVER MEDAL AT
OLYMPIC GAMES



GRAF

GRAF BLADES/

USAGE: Free Style | FINISH: Chrome | Sizes Range: 8-12" | INCREMENTS: 1/4"

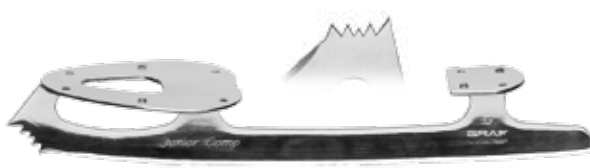

JUNIOR COMP/
 "Start me up You'll never stop"
 Advanced Performance for
 free-style skating.
 Nr. 4270 Parallel Blade
 Rocker - Hollow Radius: 8' - 7/16"
 Catalog price: Fr. 269,00 > **SPECIAL OFFER: Fr. 198,00**

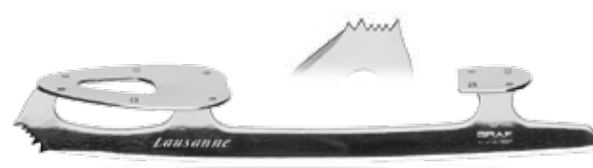

LAUSANNE/
 "Winning Formula" Advanced
 Junior Performance for
 free-style skating.
 Nr. 4265 Parallel Blade
 Rocker - Hollow Radius: 8' - 7/16"
 Catalog price: Fr. 198,00



SILVER STAR/
 A high quality mid-range
 parallel blade for professionals.
 Nr. 4275 Parallel Blade
 Rocker - Hollow Radius: 7' - 5/8"
 Catalog price: Fr. 342,00 > **SPECIAL OFFER: Fr. 198,00**



DIAMOND SE/
 "Power and Aesthetic
 Refinement" High Performance
 for free-style skating.
 NEW: Special Edge Design
 Nr. 4285SE Taper (Hollow) Blade
 Rocker - Hollow Radius: 8' - 7/6"
 Catalog price: Fr. 538,00



PLATINUM/
 "Yours to discover"
 Advanced High Performance
 for freestyle skating.
 Nr. 4280 Parallel Blade
 Rocker - Hollow Radius: 8' - 7/16"
 Catalog price: Fr. 428,00 > **SPECIAL OFFER: Fr. 250,00**



DANCE/
 A top quality dance blade,
 parallel slimline edge for
 increased glide.
 Nr. 4290 Parallel BLADE (reduced Skating edge)
 Rocker - Hollow Radius: 7' - 5/8"
 Catalog price: Fr. 459,00 > **SPECIAL OFFER: Fr. 250,00**



CYBER STAR/
 A top range free skating blade of
 the highest quality. Enlarged top
 toe pick for precise toe spotting.
 Nr. 4282 Hollow Ground Blade
 Rocker - Hollow Radius: 7' - 5/8"
 Catalog price: Fr. 554,00 > **SPECIAL OFFER: Fr. 250,00**

Offizieller Händler - Official distributor - Distributeur officiel

BOOT - BLADES:

Nominal values: real sizes may vary by pair of skates.

Boot size UK	13c	1	1,5	2	2,5	3	3,5	4	4,5	5	5,5	6	6,5	7	7,5	8	8,5	9	9,5	10	10,5	11	11,5	12
FR	31 2/3	33	33 2/3	34 1/3	34 2/3	35 1/3	36	36 2/3	37 1/3	38	38 2/3	39 1/3	40	40 2/3	41 1/3	42	42 2/3	43 1/3	44	44 2/3	45 1/3	46	46 2/3	47 1/3
Sole length (mm)	205	213	220	227	230	233	237	243	246	249	253	257	262	264	269	272	279	280	285	288	293	297	300	303
Blade size (inches)	8	8 1/2	8 3/4	8 3/4	9	9	9 1/4	9 1/2	9 1/2	9 3/4	9 3/4	10	10	10 1/4	10 1/2	10 1/2	10 3/4	11	11	11 1/4	11 1/2	11 1/2	11 3/4	11 3/4

BLADES COVERS/ GRAF



FUZZY KL/ LEOPARD
 Nr. 4912ST-LEOP S/M L/XL
 Catalog price: Fr. 24,90



FUZZY KL/ DALMATIAN (short fibers)
 Nr. 4910-DAL S/M L/XL
 Catalog price: Fr. 19,90



FUZZY KL/ ZEBRA (short fibers)
 Nr. 4910-ZEB S/M L/XL
 Catalog price: Fr. 19,90



FUZZY KL/ LEOPARD (short fibers)
 Nr. 4910-LEOP S/M L/XL
 Catalog price: Fr. 19,90



FUZZY KL/ TIGER BLUE (short fibers)
 Nr. 4910-BLTIG S/M L/XL
 Catalog price: Fr. 19,90



FUZZY KL/ PANTHER (short fibers)
 Nr. 4910-PAN S/M L/XL
 Catalog price: Fr. 19,90



FUZZY KL/ TIGER GOLD (short fibers)
 Nr. 4910-GOTIG S/M L/XL
 Catalog price: Fr. 19,90



FUZZY KL/ ROYAL BLUE (short fibers)
 Nr. 4907-44 S/M L/XL
 Catalog price: Fr. 15,90



FUZZY KL/ BLACK
 Nr. 4907-9 S/M L/XL
 Catalog price: Fr. 15,90



FUZZY KL/ EMERALD (short fibers)
 Nr. 4907-11 S/M L/XL
 Catalog price: Fr. 15,90



FUZZY KL/ RED (short fibers)
 Nr. 4907-6 S/M L/XL
 Catalog price: Fr. 15,90



FUZZY KL/ PINK (short fibers)
 Nr. 4907-60 S/M L/XL
 Catalog price: Fr. 15,90



FUZZY KL/ YELLOW FLUO (short fibers)
 Nr. 4907-55 S/M L/XL
 Catalog price: Fr. 15,90

GRAF ACCESSORIES/



BOTTLE/

Nr. 49410 0,7 lt

Catalog price: Fr. 9,90



PROTECTION/ White color

Nr. 4900 P. PAIR

Catalog price: Fr. 11,90



UNIVERS PROTECTION GLITTER/ Yellow, Blue, Green, Fuxia

Nr. 4902 P. PAIR

Catalog price: Fr. 14,90



LACES/ White

Nr. 4132-0 - 220 cm PAIR

Catalog price: Fr. 5,00

Nr. 4132-0 - 250 cm PAIR

Catalog price: Fr. 5,50

Nr. 4132-0 - 280 cm PAIR

Catalog price: Fr. 6,00

Nr. 4132-0 - 305 cm PAIR

Catalog price: Fr. 6,50



UNIVERS PROTECTION/ Red, yellow, blue, green, black white or silver color

Nr. 4901 P. PAIR

Catalog price: Fr. 14,90



LACES/ Black

Nr. 4132-9 - 280 cm PAIR

Catalog price: Fr. 6,00

Nr. 4132-9 - 305 cm PAIR

Catalog price: Fr. 6,50



LACES/ Beige

Nr. 4132-8 - 250 cm PAIR

Catalog price: Fr. 5,50

Nr. 4132-8 - 280 cm PAIR

Catalog price: Fr. 6,00

Nr. 4132-8 - 305 cm PAIR

Catalog price: Fr. 6,50



GLOVES/

Size M

Size M

Size M

Size S - M - L

Size S - M - L

Nr. 45110-06 - Fuxia / Nr. 45110-55 - Yellow Fluo / Nr. 45110-11 - Green Fluo / Nr. 45110-66 - Orange Fluo / Nr. 45110-9 - Black / Nr. 45110-8 - Beige

Catalog price: Fr. 10,00

ANATOMICAL FOOTBED/ GRAF

EN

- Navicular Bone Support: Your position in the shoe is always in line
- Constant pressure distribution on skates
- Reduced fatigue of ankle joint
- Centered power transmission to blades and ice
- Eudermic material, antibacterial and quick drying

DE

- Kahnbeinabstützung: Sie stehen immer gerade im Schuh
- Gleichmäßige Druckverteilung auf den Schuh
- Reduzierte Ermüdung der Fussgelenke
- Zentriert Kraftübertragung auf Kufe und Eis
- Material: Hautfreundlich, antibakteriell und schnell trocknend

FR

- Support du Navicular Os: Votre Position du pied est toujours en ligne droite
- Pression régulièrement équilibrée sur la chaussure
- Transmission d'énergie centrée sur lames et glace
- Fatigue réduite du malléole (d'articulation du pied)
- Material antibactérien, neutre à la réaction dermique, séchant rapidement



ANATOM FOOTBED/

Nr. 49152 w 7C - 12

Catalog price: Fr. 49,90

GRAF CLASSIC INSOLE/

Nr. 49126 w 2 - 11.5

Catalog price: Fr. 19,00

ACCESSORIES/BAG



TROLLEYBAG WITH WHEELS/ 48 x 34 x 27 cm

Nr. 4030-61 Red-white

Nr. 4030-97 Black-fuxia

Catalog price: Fr. 79,90

Action price: Fr. 69,90



SPORT BAG/ Pink

Nr. 4032-66 33 x 44 Cm

Catalog price: Fr. 9,90

SHOULDER BAG/ 38 x 24 x 34 cm

Nr. 4009-4 Blue

Nr. 4009-6 Red

Nr. 4009-9 Black

Catalog price: Fr. 24,00





SEAMLESS LEGGINGS/BROKEN ICE

NEW

EN

- 3D seamless technology.
- Comfortable waist band.
- Extra-soft microfiber yarn.
- Anti-odor and bacterial treatment.
- Weight: 85 g - 3,0 oz.
- Material: 94% Polyamide - 6% Elastane.

DE

- Sehr dehnbarer, weicher Maschenstoff aus 3D-Seamless Strickarbeit.
- Optimaler Feuchtigkeitstransport.
- Angenehme Wärmeisolierung.
- Sehr flaches integriertes Bündchen.
- Geruchshemmende und antibakterielle Behandlung.
- Gewicht: 85 g - 3,0 oz.
- Material: 94% Polyamid - 6% Elastan.



Available woman sizes/

Nr. 45135-04	BLUE	J2-J4	Catalog price: Fr. 69,90
Nr. 45135-06	FUXIA	J2-J5	Catalog price: Fr. 69,90
Nr. 45135-6	ORANGE	J2-J4	Catalog price: Fr. 69,90

SIZE	AGE	HEIGHT
J1	4 - 6	104 - 120 cm / 3'4 - 3'9
J2	7 - 9	120 - 134 cm / 3'9 - 4'4
J3	10 - 12	134 - 152 cm / 4'4 - 5
J4	13 - 15	152 - 167 cm / 5 - 5'5
J5	16 - 18	167 - 180 cm / 5'5 - 5'9



SEAMLESS PERFORMANCE SHIRT/BROKEN ICE

NEW



EN

- Seamless technology.
- Smooth flatlock seams for increased comfort.
- 3D High elasticity.
- Ergonomic lightweight natural stretch with breathable nets and mesh insert for perfect breathability and motions.
- Extreme moisture absorption and heat insulation.
- Antibacterial treatment.
- Weight: 150 g - 3,0 oz.
- Material: 52% Polypropylene - 45% Polyamide - 3% Elastane

DE

- Seamless Technologie.
- Keine Seitennähte.
- 3D Hochelastisch.
- Perfekter Schweißtransport.
- Erhöhte Feuchtigkeitsaufnahme und Wärmeisolation.
- Antibakterielle Behandlung.
- Gewicht: 150 g - 3,0 oz.
- Material: 52% Polypropylen - 45% Polyamid - 3% Elastan

Available woman sizes/

Nr. 45225-04	BLUE	XS/S/M/L	Catalog price: Fr. 74,90	Nr. 45225-06	ORANGE	XS/S/M/L	Catalog price: Fr. 74,90
NEW: Size XS				NEW: Size XS			
				Nr. 45225-09	BLACK	XS/S/M/L	Catalog price: Fr. 74,90
				NEW: Size XS			

GRAF SIZE	SIZE	HEIGHT
XS	32 - 34	140 - 150 cm
S	36 - 38	158 - 166 cm
M	38 - 40	164 - 170 cm
L	42 - 44	168 - 174 cm

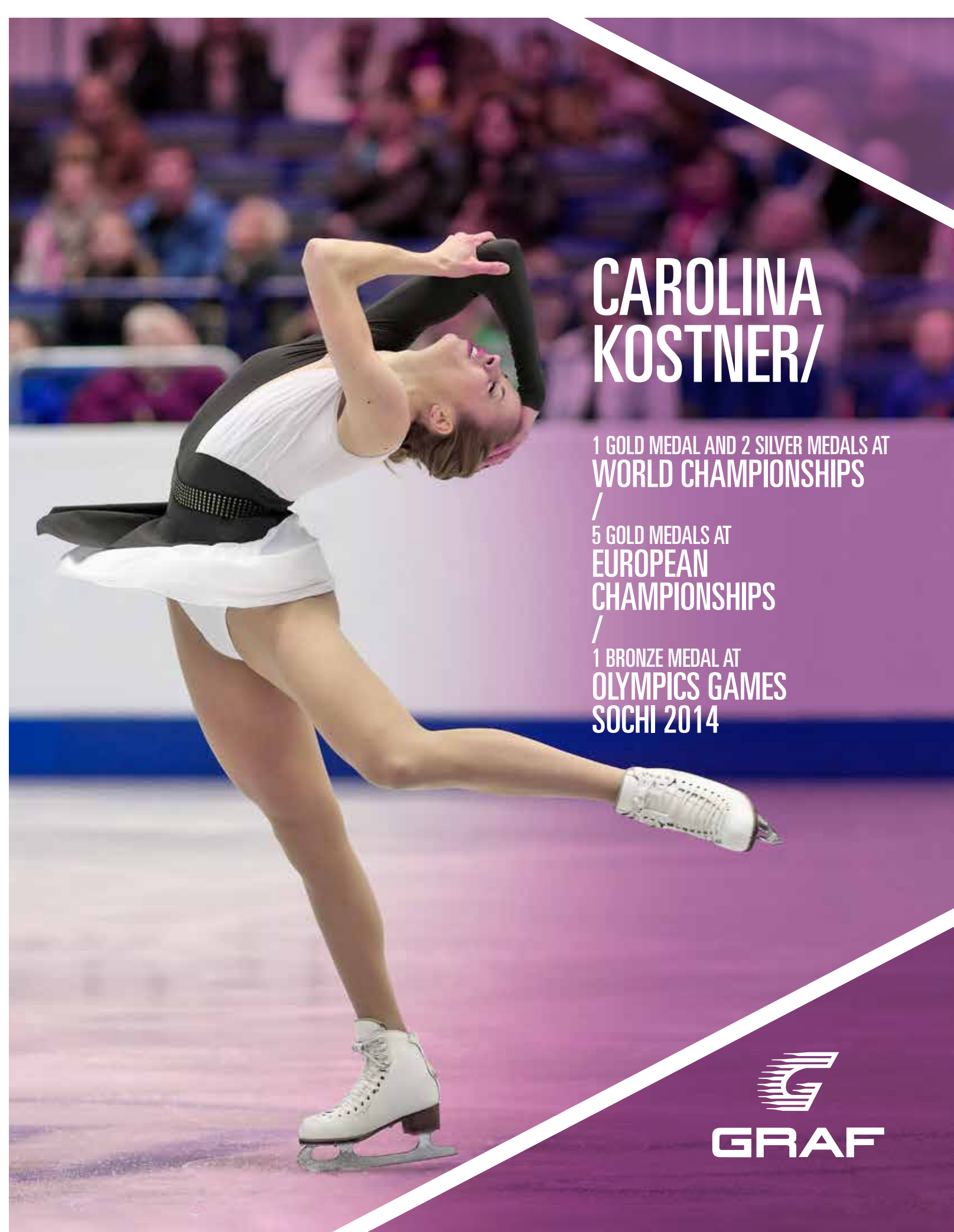

CAROLINA KOSTNER/

1 GOLD MEDAL AND 2 SILVER MEDALS AT
WORLD CHAMPIONSHIPS
/
5 GOLD MEDALS AT
EUROPEAN CHAMPIONSHIPS
/
1 BRONZE MEDAL AT
OLYMPICS GAMES
SOCHI 2014



TURTLE NECK BODY/



ROUND NECK BODY/



EN

- Seamfree long-sleeve round neck bodysuit.
- High stretch 3D material.
- Moisture management.
- Thermally insulating.
- Anti-odor and bacterial treatment.

- Antibacterial gusset.
- Plastic bottom snaps anti-allergic.
- Weight: 80 g - 2,8 oz.
- Material: 90% Nylon - 10% Elastane.

Available woman sizes/ Skin color

Nr. 45120-8	TURTLE NECK	J 1-5	Catalog: Fr. 69,90
Nr. 45122-8	ROUND NECK	J 1-5	Catalog: Fr. 69,90

DE

- Seamless Langarm Body mit rundem Halsausschnitt.
- Hochelastisches 3D Material.
- Optimaler Feuchtigkeitstransport.
- Angenehmer Wärmerückhalt.
- Antibakterieller Schutz.
- Antibakterieller nahtloser Zwickel.
- Antiallergische Plastik-Druckknöpfe.
- Gewicht: 80 g - 2,8 oz.
- Material: 90% Nylon - 10% Elastan.

SIZE	AGE	HEIGHT
J1	4 - 6	104 - 120 cm / 3'4 - 3'9
J2	7 - 9	120 - 134 cm / 3'9 - 4'4
J3	10 - 12	134 - 152 cm / 4'4 - 5
J4	13 - 15	152 - 167 cm / 5 - 5'5
J5	16 - 18	167 - 180 cm / 5'5 - 5'9

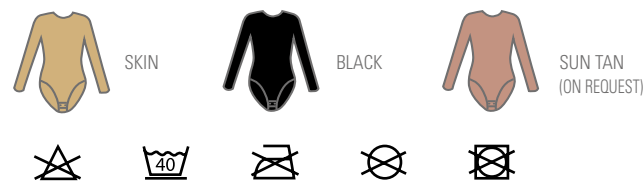

SEAMLESS LEGGINGS/

EN

- 3D seamless technology.
- Comfortable waist band.
- Extra-soft microfiber yarn.
- Anti-odor and bacterial treatment.
- Weight: 85 g - 3,0 oz.
- Material: 94% Nylon - 6% Elastane.

DE

- Sehr dehnbarer, weicher Maschenstoff aus 3D-Seamless Strickarbeit.
- Optimaler Feuchtigkeitstransport.
- Angenehme Wärmeisolierung.
- Sehr flaches integriertes Bündchen.
- Geruchshemmende und antibakterielle Behandlung
- Gewicht: 85 g - 3,0 oz.
- Material: 94% Nylon - 6% Elastan.

Available woman sizes/

Nr. 45130-9	LEGGINGS - BLACK OVER HEEL	J 1-5	Catalog price: Fr. 59,90 - Action Fr. 39,90
Nr. 45132-9	LEGGINGS - BLACK	J 2-5	Catalog price: Fr. 59,90
Nr. 45134-04	LEGGINGS - SKY BLUE	J 2-5	Catalog price: Fr. 59,90
Nr. 45134-06	LEGGINGS - FUXIA	J 2-5	Catalog price: Fr. 59,90



LEGGINS/



HEEL FIT LEGGINS/



BAND LEGGINS/



SIZE	AGE	HEIGHT
J1	4 - 6	104 - 120 cm / 3'4 - 3'9
J2	7 - 9	120 - 134 cm / 3'9 - 4'4
J3	10 - 12	134 - 152 cm / 4'4 - 5
J4	13 - 15	152 - 167 cm / 5 - 5'5
J5	16 - 18	167 - 180 cm / 5'5 - 5'9

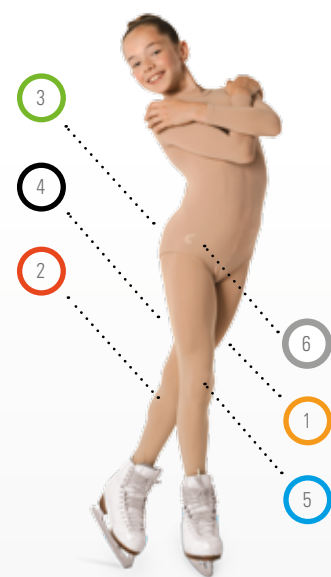
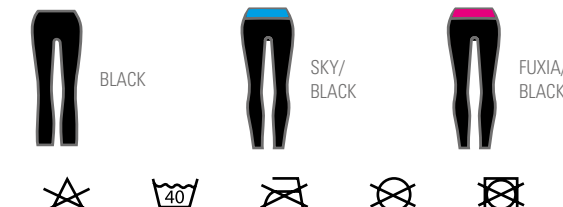

EN

- 70 den
- 3D technology.
- Comfortable waist band.
- Extra-soft microfiber yarn.
- Anti-odor and bacterial treatment.
- Body color match
- Material: 93% Nylon - 7% Elastane.

DE

- 70 Denier blickdichte Strumpfhose.
- 3D Technik.
- Komfort Bund.
- Weiche Mikrofaser.
- Geruchshemmendes antibakterielles Material.
- Body Farbgleich.
- Material: 93% Nylon - 7% Elastan.

70 DENIER TIGHTS/

Available woman sizes/

Nr. 45140-8	SKIN COLOR - FOOTED	6-9/10-12/S/M/L	Catalog price: Fr. 19,90 - Action Fr. 13,90
Nr. 45142-8	SKIN COLOR - OVER BOOT	6-9/10-12/S/M/L	Catalog price: Fr. 24,90
Nr. 45144-8	SKIN COLOR - VELCRO	S/M/L	Catalog price: Fr. 24,90

BOOT TIGHT/



VELCRO TIGHT/



FOOTED TIGHT/



SIZE	AGE	HEIGHT
J1	6 - 9	110 - 130 cm / 3'6 - 4'2
J2	10 - 12	135 - 140 cm / 4'4 - 4'6
J3	S	145 - 160 cm / 4'7 - 5'2
J4	M	160 - 170 cm / 5'2 - 5'5
J5	L	165 - 180 cm / 5'4 - 5'9

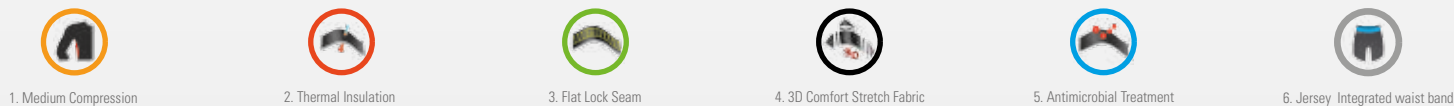

SEAMLESS PERFORMANCE SHIRT/

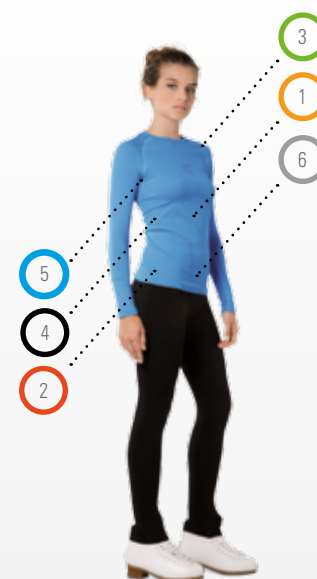

EN

- Seamless technology.
- Smooth flatlock seams for increased comfort.
- 3D High elasticity.
- Ergonomic lightweight natural stretch with breathable nets and mesh insert for perfect breathability and motions.
- Extreme moisture absorption and heat insulation.
- Antibacterial treatment.
- Weight: 150 g - 3,0 oz.
- Material: 79% Nylon - 18% Polypropylen - 3% Elastane

DE

- Seamless Technologie.
- Keine Seitennähte.
- 3D Hochelastisch.
- Perfekter Schweißtransport.
- Erhöhte Feuchtigkeitsaufnahme und Wärmeisolation.
- Antibakterielle Behandlung.
- Gewicht: 150 g - 3,0 oz.
- Material: 79% Nylon - 18% Polypropylen - 3% Elastan

Available woman sizes/

Nr. 45220-04	SKY BLUE	XS/S/M/L	Catalog price: Fr. 69,90	Nr. 45220-9	BLACK	XS/S/M/L	Catalog price: Fr. 69,90
NEW: Size XS				NEW: Size XS			
				Nr. 45220-06	FUXIA	XS/S/M/L	Catalog price: Fr. 69,90
				NEW: Size XS			

GRAF SIZE	SIZE	HEIGHT
XS	34 - 36	140 - 150 cm
S	36 - 38	158 - 166 cm
M	38 - 40	164 - 170 cm
L	42 - 44	168 - 174 cm





WWW.GRAFSKATES.CH

SKATE SIZE CONVERSION TABLE/

UK	7c	8c	9c	10c	11c	12c	13c	13,5c	1	1.5	2	2.5	3	3.5	4	4.5
FR	24 1/2	25 1/3	26 2/3	28	29 1/3	30 1/3	31 2/3	32 1/3	33	33 2/3	34 1/3	34 2/3	35 1/3	36	36 2/3	37 1/3
mm	151	156	164	171	190	196	202	204	206	210	215	219	223	227	231	235

UK	5	5.5	6	6.5	7	7.5	8	8.5	9	9.5	10	10.5	11	11.5	12
FR	38	38 2/3	39 1/3	40	40 2/3	41 1/3	42	42 2/3	43 1/3	44	44 2/3	45 1/3	46	46 2/3	47 1/3
mm	240	245	249	253	257	261	265	270	274	279	283	287	291	295	299

● Full sizes / Ganze Grössen / Pointures entières

▶ Half sizes / Halbe Grössen / Demie pointures

S=Small M=Medium L=Large

C= Narrow D= Regular EE= Wide

Prices and models are subjects of fluctuations / Preis und Modelländerungen vorbehalten
Prix et modèles sous réserve de changement

GRAF SKATES WORLDWIDE

 **GRAF SKATES AG**
WIESENSTRASSE 1
 CH-8280 KREUZLINGEN
 TEL: +41 (0) 71 - 672 57 57
FAX: +41 (0) 71 - 672 57 80
support@grafskates.ch

 **GRAF SKATES GMBH**
Julius-Probst-Str. 4
DE-87600 Kaufbeuren
TEL: +49 (0) 8341-9993600
FAX +49 (0) 8341- 9993601
info@graf-skates.de

 **GRAF HOCKEY s.r.o.**
S.K.Neumannna 3627/3
 466 04 Jablonec nad Nisou
Czech republic
 TEL: +420 602 200 105
obchod@grafhockey.eu